



Gravity[®] 
stand your ground.

PREMIUM STANDS
CATALOGUE

5 YEAR
GUARANTEE

DESIGNED & ENGINEERED
IN GERMANY.



PREMIUM STANDS
CATALOGUE



Gravity® is a brand of the Adam Hall Group.



SOUND TECHNOLOGY **LIGHT** TECHNOLOGY **STAGE** EQUIPMENT **HARDWARE** FOR FLIGHTCASES

ADAM HALL GROUP BRANDS



DISTRIBUTION BRANDS





reddot award 2016
winner

CATEGORY
MICROPHONE
STANDS



german
brand
award
17
nominee



GERMAN
DESIGN
AWARD
WINNER
2017

DESIGN MEETS QUALITY

THE NEW PREMIUM STANDS BY GRAVITY®

Gravity® is an award-winning line of stands and accessories for stage and studio use and a brand of the Adam Hall Group. Expert engineers and users have teamed up to create thoroughly professional products with innovative details such as our unique colour coding rings.

Two years of extensive research and development have resulted in a comprehensive selection of high-quality stands and accessories that are built for reliable functionality and longevity. Gravity® products are made of superior materials only including thick-walled precision tubing, die-cast zinc and double injection molded thermoplastics.

With their durable heavy-duty construction, quick and easy handling and contemporary looks Gravity® stands and accessories are the perfect choice when only pro quality products will do. Committed to superior design, workmanship and functionality, we provide a 5-year warranty on all Gravity products.

Gravity® - Stand your ground.

- ✓ 5-year warranty on all Gravity products.
- ✓ Stands and accessories for stage and studio use.
- ✓ Professional functionality with innovative details.
- ✓ Designed and engineered in Germany.
- ✓ Ultra durable construction, built to last.
- ✓ High strength precision tubing and die-cast zinc components.
- ✓ Soft touch rubber-coated clamps and knobs.
- ✓ Double injection molded adjustment knobs.
- ✓ Replaceable rubber marker rings for colour coding and personalizing your stand.

gravitystands.com

G-RINGS

THE STYLE FACTOR

At Gravity, we believe that stands are more than just accessories. Ultimately, they are part of the show. That's why we build them for heavy duty use and easy, ergonomic handling. But we also opted for a stylish look that sets them apart from dime-a-dozen stands and makes a strong visual statement.

Gravity products feature our unique sheen green "G" rings that are replaceable in seconds. Available in a variety of attractive colours, you can now customize your stands with additional ring packs and match them to your show's visuals, music genre or personal preference.

What's more, the smart "G" ring concept provides convenient colour coding to indicate a stand's intended purpose, placement on stage or the performer to use it. Just pick your colours to add style and distinction to your stands, or choose Vanta Black "G" rings for a classic, discreet look. Black rings are included with all Gravity products.

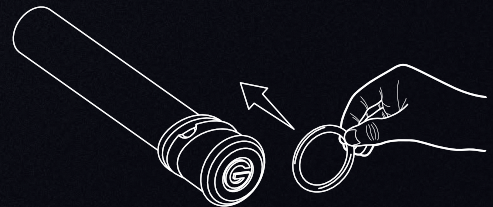

AVAILABLE COLOURS:

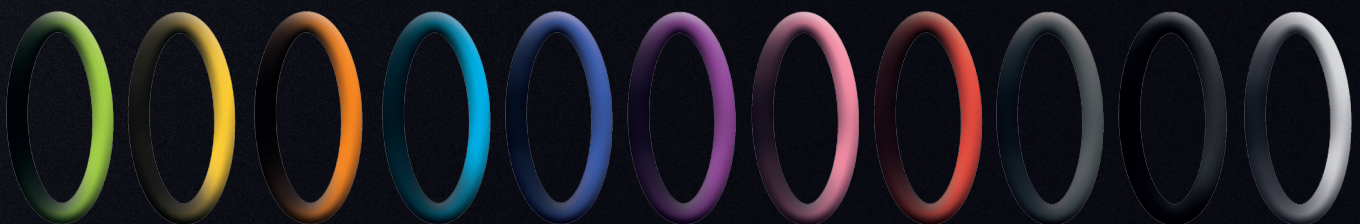

Sheen
Green

Sunshine
Yellow

Electric
Orange

Deep Sky
Blue

Deep Sea
blue

Power
purple

Misty Rose
Pink

Lust
Red

Concrete
Grey

Vanta
Black

Ghost
White



Universal Ring Pack

suitable for all Gravity products.

Contents: 5 x 15 mm, 5 x 20 mm,
5 x 25 mm, 5 x 30 mm

Vanta Black:	GRP5555BLK1
Ghost White:	GRP5555WHT1
Concrete Grey:	GRP5555GRY1
Lust Red:	GRP5555RED1
Sunshine Yellow:	GRP5555YEL1
Sheen Green:	GRP5555GRN1
Deep Sky Blue:	GRP5555BLU1
Deep Sea Blue:	GRP5555BLU2
Electric Orange:	GRP5555ORG1
Misty Rose Pink:	GRP5555PNK1
Power Purple:	GRP5555PPL1



GRAVITY ORIGINAL REPLACEMENT PARTS

Built for durability and longevity, Gravity products are constructed from premium quality materials, such as heavy duty aluminum and steel, tough die cast zinc and hardwearing thermoplastics.

In the unlikely event that the strains of stage and studio use take their toll, we offer a comprehensive selection of original replacement parts.

Gravity replacement parts are field serviceable enabling easy repair to extend the life of your Gravity product and provide an eco-friendly alternative to the planned obsolescence of throwaway designs.



CONTENTS

Microphone Stands	P. 10
Speaker Stands	P. 24
Keyboard Stands	P. 46
Music Stands	P. 50
Lighting Stands	P. 56
Guitar Stands	P. 62
Accessories	P. 72



MICROPHONE STANDS

Gravity microphone stands are easy to handle and built to last. Featuring strong, thick-walled tubing with a tough powder coating finish, they are available in folding tripod and round cast iron base versions with ergonomic clutch handles and set-screw knobs for quick, convenient setup. Gravity mic stands include straight 2-point boom adjustment models providing maximum user comfort.

MICROPHONE STANDS

FEATURES



Telescopic boom with quick release clamp for easy adjustment



Comfortable ergonomic knobs with thermoplastic rubber coating



Super accurate and stable 2-point boom joint



Soft touch rubber clutch handle for nonslip height adjustment



Specially tooled ergonomic retainer nut

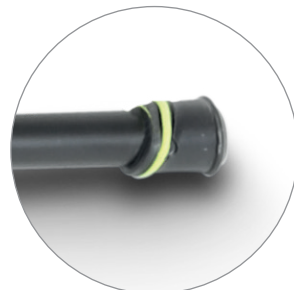

High quality rubber feet



Ultra-sturdy tripod leg collar





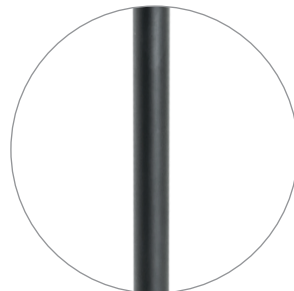





Circular base plate with rubber bottom for acoustic isolation and surface protection



Heavy-duty tubing

MICROPHONE STAND ORDER GUIDE

Gravity Microphone Stand product numbers use a simple code.
Please, use the guide below for correct model identification.

	BASE TYPE	HEIGHT	BOOM ADJUSTMENT	BOOM TYPE	EXAMPLE
	 CODE 2	 CODE 2		 CODE 1	
	 CODE 4	 CODE 3	 CODE 2	 CODE 2	
G M S	4	3	2	2	GMS4322
Gravity Microphone Stand					RESULTING ARTICLE NUMBER

MICROPHONE STANDS

ONE-HAND CLUTCH TRIPOD MICROPHONE STAND

The MS 431 HB is a premium quality microphone stand with thick walled tubing, powder coated finish and 179 cm maximum height. The heavy duty tripod base is made of die cast zinc for an accurate fit of the ultra strong folding legs of steel with hefty rubber caps for surface protection. The MS 431 HB sports a slim, innovative clutch for convenient one-handed height adjustment.

The ergonomic design and soft touch surface of the clutch handle provide a secure grip in all situations. The custom designed retainer requires no tools for quick and secure microphone clip attachment. A set of black coding rings is included with the MS 431 HB, additional ring packs are available in a wide array of colours for instant personalization.



Straight Microphone Stand

featuring folding tripod and one-hand height adjustment

Product number	GMS431HB
Type	Microphone stands
Tube material	Steel
Tubing colour	Black
Tubing surface	Powder coated
Min. height	1090 mm
Max. height	1790 mm
Transport length	1090 mm
Height adjustment	Yes
Base type	Tripod
Base material	Zinc die-cast
Interchangeable rings	1 x 15 mm, 4 x 20 mm
Black ring pack included	Yes
Weight	2.6 kg

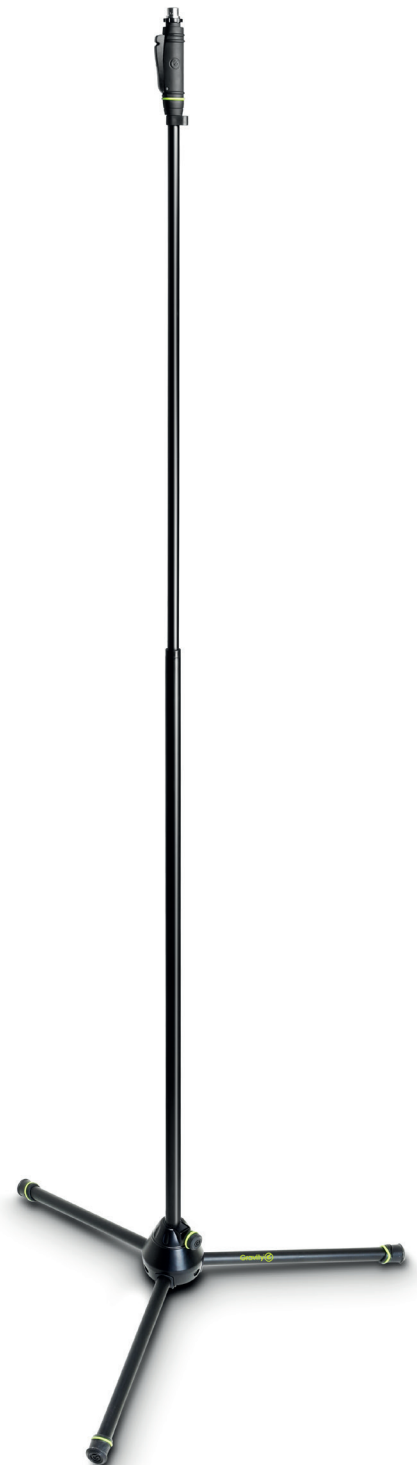



Straight Microphone Stand
with Folding Tripod Base

Product number	GMS43
Type	Microphone stands
Tube material	Steel
Tubing colour	Black
Tubing surface	Powder coated
Min. height	1030 mm
Max. height	1690 mm
Transport length	900 mm
Height adjustment	Yes
Base type	Tripod
Base material	Zinc die-cast
Interchangeable rings	1 x 15 mm, 4 x 20 mm
Black ring pack incl.	Yes
Weight	2.3 kg



Microphone Stand
with Folding Tripod Base and 2-Point
Adjustment Boom

Product number	GMS4321B
Type	Microphone stands
Tube material	Steel
Tubing colour	Black
Tubing surface	Powder coated
Min. height	1030 mm
Max. height	1690 mm
Transport length	1050 mm
Height adjustment	Yes
Base type	Tripod
Base material	Zinc die-cast
Boom model	2-point adjustment
Boom length	790 mm
Interchangeable rings	1 x 25 mm, 2 x 15 mm, 4 x 20 mm
Black ring pack incl.	Yes
Weight	2.7 kg



Microphone Stand
with Folding Tripod Base and 2-Point
Adjustment Telescoping Boom

Product number	GMS4322B / W
Type	Microphone stands
Tube material	Steel
Tubing colour	Black / white
Tubing surface	Powder coated
Min. height	1030 mm
Max. height	1690 mm
Transport length	1050 mm
Height adjustment	Yes
Base type	Tripod
Base material	Zinc die-cast
Boom model	2-point adjustment
Boom length	880 mm
Interchangeable rings	1 x 25 mm, 2 x 15 mm, 4 x 20 mm
Black ring pack incl.	Yes
Weight	2.7 kg

MICROPHONE STANDS



Short Microphone Stand
with Folding Tripod Base and 2-Point
Adjustment Boom

Product number	GMS4221B
Type	Microphone stands
Tube material	Steel
Tubing colour	Black
Tubing surface	Powder coated
Min. height	510 mm
Max. height	740 mm
Transport length	600 mm
Height adjustment	Yes
Base type	Tripod
Base material	Zinc die-cast
Boom model	2-point adjustment
Boom length	500 mm
Interchangeable rings	1 x 25 mm, 2 x 15 mm, 4 x 20 mm
Black ring pack incl.	Yes
Weight	2.2 kg



Short Microphone Stand
with Folding Tripod Base and 2-Point
Adjustment Telescoping Boom

Product number	GMS4222B
Type	Microphone stands
Tube material	Steel
Tubing colour	Black
Tubing surface	Powder coated
Min. height	510 mm
Max. height	740 mm
Transport length	650 mm
Height adjustment	Yes
Base type	Tripod
Base material	Zinc die-cast
Boom model	2-point adjustment
Boom length	880 mm
Interchangeable rings	1 x 25 mm, 2 x 15 mm, 4 x 20 mm
Black ring pack incl.	Yes
Weight	2.2 kg



Heavy Base
for Bass Drum Mic'ing!

Short Microphone Stand
with Folding Tripod Base

Product number	GMS3122HDB
Type	Microphone stands
Tube material	Steel
Tubing colour	Black
Tubing surface	Powder coated
Max. height	320 mm
Transport length	500 mm
Height adjustment	No
Base type	Tripod
Base material	Zinc die-cast
Boom model	2-point adjustment
Boom length	880 mm
Interchangeable rings	Yes
Black ring pack incl.	Yes
Weight	2.84 kg

ONE-HAND CLUTCH ROUND BASE PLATE MICROPHONE STANDS

The MS 231 HB is a premium quality microphone stand with thick walled tubing, powder coated finish and 175 cm maximum height. Made of cast iron, the heavy duty round base features a rubber ring at the bottom for acoustic isolation and surface protection. The MS 231 HB sports a slim, innovative clutch for convenient one-handed height adjustment. The ergonomic design and soft touch surface of the clutch handle provide a secure grip in all situations. The custom designed retainer requires no tools for quick and secure microphone clip attachment. A set of black coding rings is included with the MS 231 HB, additional ring packs are available in a wide array of colours for instant personalization. For increased stability we offer a 2.3 kg add-on weight plate that installs without tools (part no. GMS2WP).



Microphone Stand

with Round Base and One-Hand Clutch

Product number	GMS231HB
Type	Microphone stands
Tube material	Steel
Tubing colour	Black
Tubing surface	Powder coated
Min. height	1080 mm
Max. height	1750 mm
Transport length	1080 mm
Height adjustment	Yes
Base type	Round base
Vari-Weight* compatible	Yes
Base material	Cast iron
Base weight	3.6 kg
Interchangeable rings	1 x 20 mm
Black ring pack incl.	Yes
Weight	4.4 kg



MICROPHONE STANDS



Straight Microphone Stand
with Round Base

Product number	GMS23B / W
Type	Microphone stands
Tube material	Steel
Tubing colour	Black / white
Tubing surface	Powder coated
Min. height	1000 mm
Max. height	1600 mm
Transport length	1000 mm
Height adjustment	Yes
Base type	Round base
Vari-Weight* compatible	Yes
Base material	Cast iron
Base weight	3.6 kg
Interchangeable rings	1 x 20 mm
Black ring pack incl.	Yes
Weight	4 kg

Microphone Stand
with Round Base and 2-Point
Adjustment Boom

Product number	GMS2321B
Type	Microphone stands
Tube material	Steel
Tubing colour	Black
Tubing surface	Powder coated
Min. height	1000 mm
Max. height	1680 mm
Transport length	1000 mm
Height adjustment	Yes
Base type	Round base
Vari-Weight* compatible	Yes
Base material	Cast iron
Base weight	3.6 kg
Boom model	2-point adjustment
Boom length	790 mm
Interchangeable rings	1 x 15 mm, 1 x 20 mm, 1 x 25 mm
Black ring pack incl.	Yes
Weight	4.8 kg

Microphone Stand
with Round Base and 2-Point
Adjustment Telescoping Boom

Product number	GMS2322B
Type	Microphone stands
Tube material	Steel
Tubing colour	Black
Tubing surface	Powder coated
Min. height	1000 mm
Max. height	1680 mm
Transport length	1050 mm
Height adjustment	Yes
Base type	Round base
Vari-Weight* compatible	Yes
Base material	Cast iron
Base weight	3.6 kg
Boom model	2-point adjustment
Boom length	880 mm
Interchangeable rings	1 x 15 mm, 1 x 20 mm, 1 x 25 mm
Black ring pack incl.	Yes
Weight	4.8 kg



Short Microphone Stand

with Round Base and 2-Point
Adjustment Boom

Product number	GMS2221B
Type	Microphone stands
Tube material	Steel
Tubing colour	Black
Tubing surface	Powder coated
Min. height	180 mm
Max. height	730 mm
Transport length	500 mm
Height adjustment	Yes
Base type	Round base
Vari-Weight® compatible	Yes
Base material	Cast iron
Base weight	3.6 kg
Boom model	2-point adjustment
Boom length	500 mm
Interchangeable rings	1 x 20 mm, 1 x 25 mm
Black ring pack incl.	Yes
Weight	4 kg



Short Microphone Stand,

with Round Base and 2-Point Adjustment
Telescoping Boom

Product number	GMS2222B
Type	Microphone stands
Tube material	Steel
Tubing colour	Black
Tubing surface	Powder coated
Min. height	480 mm
Max. height	730 mm
Transport length	550 mm
Height adjustment	Yes
Base type	Round base
Vari-Weight® compatible	Yes
Base material	Cast iron
Base weight	3.6 kg
Boom model	2-point adjustment
Boom length	880 mm
Interchangeable rings	1 x 15 mm, 1 x 20 mm, 1 x 25 mm
Black ring pack incl.	Yes
Weight	4 kg

MICROPHONE STANDS

BOOM ARM FOR MICROPHONE STANDS

This 80 cm boom arm features a cast aluminium hub with precision 2-point tilt and position adjustment and 3/8" male thread. The ergonomic set screw knobs are made from high-grade ABS with a soft touch, non-slip thermoplastic coating for comfortable operation.



2-Point Adjustment

Boom Arm

Product number	GMSB21
Tube material	Steel
Tubing colour	Black
Tubing surface	Powder coated
Boom length	800 mm
Interchangeable rings	1 x 15 mm, 1 x 25 mm
Black ring pack included	Yes
Weight	0.4 kg

TELESCOPING BOOM ARM FOR MICROPHONE STANDS

This telescoping boom arm features a cast aluminium hub with precision 2-point tilt and position adjustment and 3/8" male thread. The ergonomic set screw knobs are made from high-grade ABS with a soft touch, non-slip thermoplastic coating for comfortable operation. A convenient quick fastener allows for variable extension to a maximum length of 88 cm facilitating flexible mic placement.



2-Point Adjustment

Telescoping Boom Arm

Product number	GMSB22
Tube material	Steel
Tubing colour	Black
Tubing surface	Powder coated
Boom length	800 mm
Interchangeable rings	1 x 15 mm, 1 x 25 mm
Black ring pack included	Yes
Weight	0.4 kg

MICROPHONE STANDS

VARI-WEIGHT® WEIGHT PLATE FOR ROUND BASE MICROPHONE STANDS

Adding 2.3 kg extra weight for increased stability this cast iron plate installs to our round base mic stands without the need for tools.

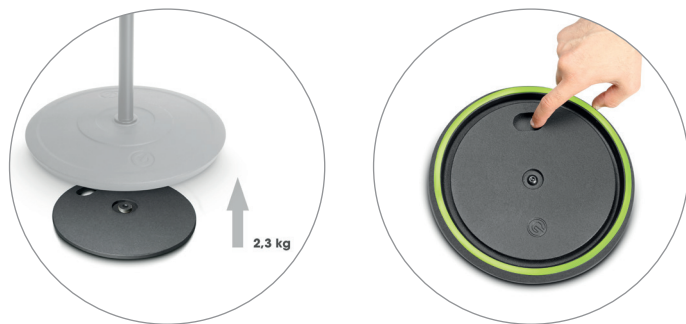

Weight Plate for Round Base Mic Stands

Product number	GMS2WP
Material	Cast iron
Colour	Black
Surface	Powder coated
Diameter	210 mm
Weight	2.3 kg







SPEAKER STANDS

Gravity® speaker stands use thick walled precision tubing, steel height adjustment collars and redesigned leg housings for maximum strength and durability. Air cushion and hand crank versions greatly facilitate lifting and lowering heavy loads, and our low-profile round base model provides an elegant, small footprint alternative to conventional tripods. In addition, the Gravity® range includes stands for your studio monitors, subwoofer poles and a selection of stand adapters.



SPEAKER STANDS

FEATURES



Sturdy, virtually indestructible steel collar with safety pin



Comfortable ergonomic knobs



Newly designed aluminum die-cast Leg collar for superior strength



Crank operation for easy speaker raising and lowering

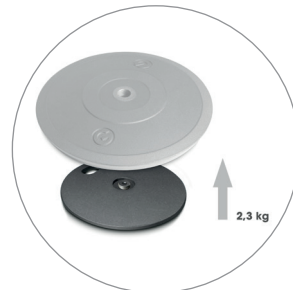

Vari-Weight® - Low-profile 9 kg cast iron base and a 5 kg weight plate which installs without tools



Tight, secure fit

TRIPOD SPEAKER STAND

The SP 5211 B is a classic tripod speaker stand made from thick walled, yet lightweight powder coated aluminum tubing with a load capacity of 50 kg and 192 cm maximum height.

The die cast aluminum leg collar has been completely redesigned to provide superior durability and longevity, the height adjustment collar is made of steel for additional strength and is virtually indestructible. It features a safety pin to securely lock the 35 mm diameter extension pole in place.

The ergonomic set screw knobs are made from high grade ABS with a soft touch, non-slip thermoplastic coating for comfortable operation.

A set of black coding rings is included with the SP 5211 B, additional ring packs are available in a wide array of colours for instant personalization.

Speaker Stand

35 mm

Product number	GSP5211B / W	GSP5212B
Type	Speaker Stands	Speaker Stands
Tube material	Aluminium	Steel
Tubing colour	Black / white	Black
Tubing surface	Powder coated	Powder coated
Min. height	1060 mm	1060 mm
Max. height	1920 mm	1920 mm
Transport length	1050 mm	1050 mm
Height adjustment	Clamp with safety pin	Clamp with safety pin
Material of height adjustment	Steel	Steel
Base type	Leg joint	Leg joint
Base material	Die-cast aluminium	Die-cast aluminium
Tubing diameter	35 mm	35 mm
Max. load	50 kg	50 kg
Interchangeable rings	5 x 30 mm	5 x 30 mm
Black ring pack included	Yes	Yes
Weight	2.2 kg	4.7 kg



SPEAKER STANDS

AIR CUSHION TRIPOD SPEAKER STAND

The SP 5211 ACB is a classic tripod speaker stand made from thick walled, yet lightweight powder coated aluminium tubing with a load capacity of 50 kg and 192 cm maximum height. The die cast aluminium leg collar has been completely redesigned to provide superior durability and longevity, the height adjustment collar is made of steel for additional strength and is virtually indestructible. It features a safety pin to securely lock the 35 mm diameter extension pole in place.

The ergonomic set screw knobs are made from high grade ABS with a soft touch, non-slip thermoplastic coating for comfortable operation. The built in air cushion acts as a pneumatic shock absorber and allows you to gently lower even heavy loads.

A set of black coding rings is included with the SP 5211 ACB, additional ring packs are available in a wide array of colours for instant personalization.

Speaker Stand

Pneumatic, 35 mm Steel

Product number	GSP5211ACB
Type	Speaker stands and tripods
Tube material	Aluminium
Tubing colour	Black
Tubing surface	Powder coated
Min. height	1060 mm
Max. height	1920 mm
Transport length	1050 mm
Height adjustment	Yes
Material of height adjustment	Steel
Base type	Tripod
Base material	Die-cast aluminium
Tubing diameter	35 mm
Max. load	50 kg
Interchangeable rings	1 x 15 mm, 1 x 25 mm
Black ring pack included	Yes
Weight	2.8 kg



CABLE CLIPS 35 MM FOR SPEAKER STANDS

Made from tough, long-lasting ABS, the Gravity 35 mm cable clips are designed for a firm, secure fit to speaker stands and subwoofer poles. They keep your cables neat and safely fixed in a large 24 x 16 mm outside duct and are sold in pairs.



Cable Clips

for 35 mm Speaker Pole Cable Clips

Product number	GSACC35B
Type	Cable clips for 35 mm tubing
Material	ABS plastic
Colour	Black
Suitable for tube diameter	34 - 35 mm
For number of cables	2 pcs.
Max. cable diameter	24 x 16 mm
Weight	0.011 kg



SPEAKER STANDS



Set of 2 Speaker Stands in Aluminium or Steel with Bag

Product number	GSS5212BSET1	GSS5211BSET1
Gravity Transportbag	GBGSS2B	GBGSS2B
Type	Stands and tripod accessories	Stands and tripod accessories
Number of stands	2	2
Type of stand	Speaker tripod	Speaker tripod
Material	Nylon 600D	Nylon 600D
Thickness of the padding	15 mm	15 mm
Latch	Double zip	Double zip
Dimensions (W x H x D)	1070 x 190 x 290 mm	1070 x 190 x 290 mm
Transport length	1050 mm	1050 mm
Gravity speaker stand	GSP5212B	GSP5211B
Type	Speaker stands	Speaker stands
Tube material	Steel	Aluminium
Tubing surface / Colour	Powder coated / black	Powder coated / black
Min. / max. height	1060 mm / 1920 mm	1060 mm / 1920 mm
Transport length	1050 mm	1050 mm
Height adjustment	Clamp with safety pin	Clamp with safety pin
Material of height adjustment	Steel	Steel
Base type / material leg joint	Die-cast aluminium	Die-cast aluminium
Tubing diameter	35 mm	35 mm
Max. load	50 kg	50 kg
Interchangeable rings	5 x 30 mm	5 x 30 mm
Black ring pack incl.	Yes	Yes
Weight	4.7 kg	2.2 kg

Set of 2 Aluminum Speaker Stands with Bag and two XLR or Speaker Cables

Product number	GSS5211BSET2	GSS5211BSET1
Gravity Transportbag	GBGSS2B	GBGSS2B
Type	Stands and tripod accessories	Stands and tripod accessories
Number of stands	2	2
Type of stand	Speaker tripod	Speaker tripod
Material	Nylon 600D	Nylon 600D
Thickness of the padding	15 mm	15 mm
Latch	Double zip	Double zip
Dimensions (W x H x D)	1070 x 190 x 290 mm	1070 x 190 x 290 mm
Transport length	1050 mm	1050 mm
Gravity speaker stand	GSP5211B	GSP5211B
Type	Speaker stands	Speaker stands
Tube material	Aluminium	Aluminium
Tubing surface / Colour	Powder coated / black	Powder coated / black
Min. / max. height	1060 mm / 1920 mm	1060 mm / 1920 mm
Transport length	1050 mm	1050 mm
Height adjustment	Clamp with safety pin	Clamp with safety pin
Material of height adjustment	Steel	Steel
Base type / material leg joint	Die-cast aluminium	Die-cast aluminium
Tubing diameter	35 mm	35 mm
Max. load	50 kg	50 kg
Interchangeable rings	5 x 30 mm	5 x 30 mm
Black ring pack incl.	Yes	Yes
Cable	2 x 5 m Standard Speaker Cables	2 x 5 m XLR Cables
Weight	2.2 kg	2.2 kg

WIND UP SPEAKER STAND

The Gravity SP 4722 B is a heavy-duty speaker stand with a convenient hand crank and rack-and-pinion that make it easy to raise your speakers to the desired height. It is made of hard-wearing steel tubing with a folding tripod base and durable cast aluminium leg collar. A large knob set screw and safety pin secure the telescoping pole, which extends from 1.5 m to a maximum height of 2.4 m. The stand is TÜV/GS certified.

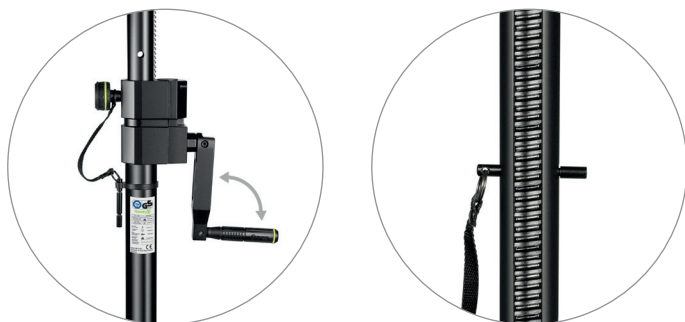

Wind Up Speaker Stand

Product number	GSP4722B
Type	Speaker stands
Tube material	Steel
Tubing colour	Black
Tubing surface	Powder coated
Min. height	1500 mm
Max. height	2400 mm
Joint material	Metal
Tubing diameter	35 mm
Max. load	50 kg
Interchangeable rings	1 x 15 mm, 2 x 20 mm, 3 x 25 mm
Black ring pack included	Yes
Weight	9.31 kg



SPEAKER STANDS

ROUND CAST IRON BASE SPEAKER STAND

Sporting a smaller footprint than conventional tripods this heavy-duty speaker stand features a 35 mm steel pole with unbreakable steel collar, ergonomic set screw knob and safety pin for easy and secure height adjustment. It extends from 1.05 to 1.8 m in 7.5 cm increments. The heavy, low-profile 9 kg cast iron base with additional 5 kg weight plate provides a secure footing and increased stability.



Speaker Stand with Round Cast Iron Base

Product number	GSSPWSET1
Gravity round cast iron base for M20 poles	GWB123B / W
Type	Speaker stands
Pedestal material	Die-cast iron
Diameter	450 mm
Colour	Black / white
Threaded connector	M20 female
Additional information	5 kg extra weight plate available
Weight	8.5 kg
Gravity round cast iron base	GWB123WPB
Material	Cast iron
Colour	Black
Surface	Powder coated
Diameter	350 mm
Features	Weight plate can be mounted quickly and without tools
Weight	5 kg
Gravity adjustable speaker pole 35 mm	GSP2342B / W
Type	Speaker stands
Tubing colour	Black / white
Tubing surface	Powder coated
Tubing diameter	35 mm
Threaded connector	M20
Min. / max. height	1050 mm / 1800 mm
Weight	2.1 kg



TWIN EXTENSION SPEAKER STAND

The SP 5522 B is a classic tripod speaker and lighting stand made from thick walled, yet lightweight powder coated steel tubing with a load capacity of 30 kg and twin extensions for a maximum height of 3 m. The diecast aluminium leg collar has been completely redesigned to provide superior durability and longevity. The unbreakable height adjustment collars are made of steel for additional strength featuring safety pins to securely lock the extensions in place. The ergonomic set screw knobs are made from high grade ABS with a soft touch, non-slip thermoplastic coating for comfortable handling.

A set of black coding rings is included with the SP 5522 B, additional ring packs are available in a wide array of colours for instant personalization.

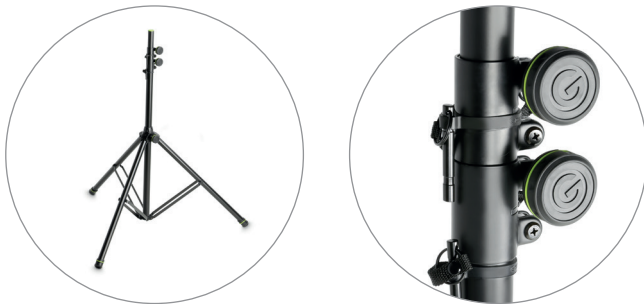

Twin Extension Speaker & Lighting Pole

Product number	GSP5522B
Type	Speaker stands
Tube material	Steel
Tubing colour	Black
Tubing surface	Powder coated
Max. height	3000 mm
Height adjustment	Yes
Material of height adjustment	Steel
Number of extensions	2
Base type	Tripod
Base material	Die-cast aluminium
Tubing diameter	35 mm
Max. load	30 kg
Interchangeable rings	5 x 30 mm
Black ring pack included	Yes
Weight	6.3 kg



SPEAKER STANDS



ROUND CAST IRON BASE AND WEIGHT PLATE SET FOR M20 POLES **SPEAKER STANDS**

This set combines a heavy, low-profile 9 kg cast iron base and a 5 kg weight plate which installs without tools. The assembly provides a secure footing and increased stability for poles with M20 male thread bottom ends.

Round Cast Iron Base

and Weight Plate Set for M20 Poles

Product number	GWB123SET1B
Gravity round cast iron base for M20 poles	GWB123B / W
Type	Speaker stands
Pedestal material	Die-cast iron
Diameter	450 mm
Colour	Black / white
Threaded connector	M20 female
Additional information	5 kg extra weight plate available
Weight	8.5 kg
Gravity round cast iron base	GWB123WPB
Material	Cast iron
Colour	Black
Surface	Powder coated
Diameter	350 mm
Features	Weight plate can be mounted quickly and without tools
Weight	5 kg

Optional Transport Bag available (GBGWB123)





Also available
without
VARI-WEIGHT®
plate in black
or white
(GWB1233B or
GWB123W)

SPEAKER STANDS

ADJUSTABLE T-BAR FOR SPEAKER STANDS

The Gravity T-Bar facilitates mounting two loudspeakers on a single stand. It is made of heavy-duty steel with a black powder-coating finish and securely attaches to all 35 mm poles. Width is fully adjustable from 31 to 49 cm.

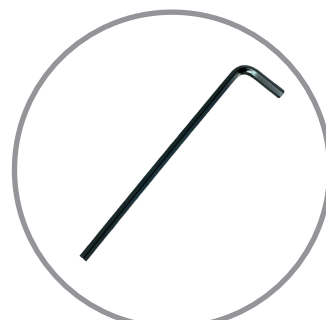

Mounting Fork for 35 mm Speaker Pole

Product number	GSAT36B
Type	Speaker Stands
Material	Steel
Colour	Black
Surface	Powder coated
Suitable for tube diameter	35 mm
Adjustable width	310 - 490 mm
Fitting	Screw clamp
Max. load	1 x 20 mm, 2 x 25 mm
Interchangeable rings	Yes
Black ring pack included	Yes
Additional information	Assembly tool
Weight	1.4 kg





Also available in white.



Speaker Pole

for 35 mm, 1800 mm High

Product number	GSP2342B / W
Type	Speaker stands
Tubing colour	Black / white
Tubing surface	Powder coated
Tube diameter	35 mm
Threaded connector	M20
Min. height	1050 mm
Max. height	1800 mm
Interchangeable rings	Yes
Weight	2.1 kg



Also available in white.



Speaker Pole

Extension

Product number	GSP2332EXTB / W
Type	Speaker stands
Material	Steel
Colour	Black / white
Surface	Powder coated
Length	500 mm
Threaded connector	M20 male
Threaded connector 2	M20 female
Interchangeable rings	No
Weight	0.9 kg

SPEAKER STANDS



Adjustable Speaker Pole

35 mm to M20, 1400 mm

Product number	GSP2332B
Type	Speaker stands
Tube material	Steel
Tubing colour	Black
Tubing surface	Powder coated
Min. height	820 mm
Max. height	1400 mm
Transport length	820 mm
Height adjustment	Yes
Material of height adjustment	Steel
Connector 1	M20
Connector 2	35 mm
Max. load	40 kg
Interchangeable rings	1 x 30 mm
Black ring pack included	Yes
Weight	1.84 kg



Adjustable Speaker Pole

35 mm to 35 mm, 1400 mm

Product number	GSP3332B
Type	Speaker stands
Tube material	Steel
Tubing colour	Black
Tubing surface	Powder coated
Min. height	820 mm
Max. height	1400 mm
Transport length	820 mm
Height adjustment	Yes
Material of height adjustment	Steel
Connector 1	35 mm
Connector 2	35 mm
Max. load	40 kg
Interchangeable rings	1 x 30 mm
Black ring pack included	Yes
Weight	1.56 kg



Adjustable Two Part Speaker Pole

35 mm to 35 mm

Product number	GSP3332TPB
Type	Speaker stands
Tube material	Steel
Tubing colour	Black
Tubing surface	Powder coated
Min. height	1050 mm
Max. height	1400 mm
Transport length	540 mm
Height adjustment	Yes
Material of height adjustment	Steel
Connector 1	35 mm
Connector 2	35 mm
Max. load	40 kg
Interchangeable rings	1 x 30 mm
Black ring pack included	Yes
Weight	2.05 kg



Adjustable Two Part Speaker Pole

35 mm to M20, 1400 mm

Product number	GSP2332TPB
Type	Speaker stands
Tube material	Steel
Tubing colour	Black
Tubing surface	Powder coated
Min. height	1050 mm
Max. height	1400 mm
Transport length	540 mm
Height adjustment	Clamp with safety pin
Material of height adjustment	Steel
Connector 1	M20
Connector 2	35 mm
Max. load	40 kg
Interchangeable rings	1 x 30 mm
Black ring pack included	Yes
Weight	2.2 kg

SPEAKER STANDS

VARI-TILT® STUDIO MONITOR SPEAKER STAND

The Gravity SP 3202 VT monitor speaker stand features a heavy triangular cast iron base and 25 x 25 cm steel tray with isolating foam rests and variable tilt up to 10°. It is height-adjustable from 90 to 150 cm for optimum speaker positioning and comes with a set of spikes that mount to the large integrated rubber feet for superior acoustic coupling to the floor.



Speaker Stand

for Studio Monitors

Product number	GSP3202VT
Type	Speaker stands
Tube material	Steel
Tubing colour	Black
Tubing surface	Powder coated
Min. height	900 mm
Max. height	1500 mm
Transport length	540 mm
Height adjustment	Yes
Base type	3 - point
Base material	Cast iron
Base edge length	292.5 mm
Lower connector	M20
Tubing diameter	42 mm / 35 mm
Max. load	50 kg
Interchangeable rings	Yes
Black ring pack included	Yes
Interchangeable rings	1 x 15 mm, 1 x 20 mm, 1 x 30 mm
Weight	7 kg
Additional information	Including acoustic isolation spikes

STUDIO MONITOR SPEAKER STAND

The Gravity SP 3202 monitor speaker stand features a heavy triangular cast iron base and 25 x 25 cm steel tray with isolating foam rests. It is height-adjustable from 90 to 150 cm for optimum speaker positioning and comes with a set of spikes that mount to the large integrated rubber feet for superior acoustic coupling to the floor.



Speaker Stand for Studio Monitors

Product number	GSP3202
Type	Speaker stands
Tube material	Steel
Tubing colour	Black
Tubing surface	Powder coated
Min. height	900 mm
Max. height	1500 mm
Transport length	540 mm
Height adjustment	Yes
Base type	3 - point
Base material	Cast iron
Base edge length	292.5 mm
Lower connector	M20
Tubing diameter	42 mm / 35 mm
Max. load	50 kg
Interchangeable rings	1 x 25 mm, 1 x 30 mm
Weight	6.5 kg
Additional information	Including acoustic isolation spikes



SPEAKER STANDS

Also available in white.



Tilt and Swivel Wall Mount

for Speakers up to 20 kg

Product number	GSPWMB20B / W
Type	Speaker stands
Material	Steel
Colour	Black / white
Surface	Powder coated
Max. load	20 kg
Weight	1.35 kg
Additional information	incl. universal mounting plate



160° swivel,
0 to 40° down tilt,
continuously variable



Easily readable tilt angle
scale



6 mm wall plate with
safety rope eyelet



Also available in white.

Tilt and Swivel Wall Mount

for Speakers up to 30 kg

Product number	GSPWMB30B / W
Type	Speaker stands
Material	Steel
Colour	Black / white
Surface	Powder coated
Max. load	30 kg
Weight	1.8 kg
Additional information	incl. universal mounting plate



160° swivel,
0 to 40° down tilt,
continuously variable



Easily readable tilt angle
scale

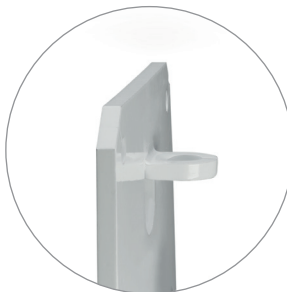

5 mm wall plate with
safety rope eyelet

SPEAKER STANDS



Variable Speaker Tilt Adapter

Product number	GSAVARITILT
Type	Speaker stands and tripod accessories
Tube material	Steel
Tubing colour	Black
Tubing surface	Powder coated
Suitable for tube diameter	35 mm
Tilt angle	0 - 15°
Length	190 mm
Max. load	30 kg
Interchangeable rings	2 x 25 mm
Black ring pack included	Yes
Weight	0.6 kg



5° Speaker Tilt Adapter

Product number	GSAFIXTILT5
Type	Speaker stands and tripod accessories
Tube material	Steel
Tubing colour	Black
Tubing surface	Powder coated
Suitable for tube diameter	35 mm
Tilt angle	5°
Length	190 mm
Max. load	30 kg
Interchangeable rings	1 x 25 mm
Black ring pack included	Yes
Weight	0.5 kg



Reducer Flange from 36 mm to 3/8" male

Product number	GSF36Z38M
Type	Speaker stands and tripod accessories
Tube material	Steel
Tubing colour	Black
Tubing surface	Powder coated
Suitable for tube diameter	35 mm
Threaded connector	3/8" x 12 mm
Type of adjustment	Screw clamp
Length	100 mm
Interchangeable rings	1 x 25 mm
Black ring pack included	Yes
Weight	0.53 kg



Reducer Flange from 36 mm to M6 male

Product number	GSF36M6M
Type	Speaker stands and tripod accessories
Tube material	Steel
Tubing colour	Black
Tubing surface	Powder coated
Suitable for tube diameter	35 mm
Threaded connector	M6 x 12 mm
Type of adjustment	Screw clamp
Length	100 mm
Interchangeable rings	1 x 25 mm
Black ring pack included	Yes
Weight	0.53 kg



Reducer Flange from 36 mm to M10 male

Product number	GSF36M10M
Type	Speaker stands and tripod accessories
Tube material	Steel
Tubing colour	Black
Tubing surface	Powder coated
Suitable for tube diameter	35 mm
Threaded connector	M10
Type of adjustment	Screw clamp
Length	100 mm
Interchangeable rings	1 x 25 mm
Black ring pack included	Yes
Weight	0.53 kg



Reducer Flange from 36 mm to M10 female

Product number	GSF36M10F
Type	Speaker stands and tripod accessories
Tube material	Steel
Tubing colour	Black
Tubing surface	Powder coated
Suitable for tube diameter	35 mm
Threaded connector	M10 Thread
Type of adjustment	Screw clamp
Length	100 mm
Interchangeable rings	1 x 25 mm
Black ring pack included	Yes
Weight	0.53 kg
Accessories (included)	Bolt M10 x 25 / washer



Reducer Flange from 36 mm to 16 mm male

Product number	GSF3616M
Type	Speaker stands and tripod accessories
Tube material	Steel
Tubing colour	Black
Tubing surface	Powder coated
Suitable for tube diameter	35 mm
Reduced to	16 mm
Type of adjustment	Screw clamp
Length	140 mm
Interchangeable rings	1 x 25 mm
Black ring pack included	Yes
Weight	0.53 kg



Reducer Flange from 36 mm to TV28 female

Product number	GSF36T28F
Type	Speaker stands and tripod accessories
Tube material	Steel
Tubing colour	Black
Tubing surface	Powder coated
Suitable for tube diameter	35 mm
Threaded connector	28 mm (TV28)
Type of adjustment	Screw clamp
Length	100 mm
Interchangeable rings	1 x 25 mm
Black ring pack included	Yes
Weight	0.72 kg





KEYBOARD STANDS

Gravity keyboard stands are designed for safe support and easy portability. They include single and double X-braced models that are made of heavy duty steel with reinforced joints, durable powder coating and grippy pads. Gravity keyboard stands provide easy setup and height adjustment for sitting or standing playing positions.

KEYBOARD STANDS

FEATURES



Black rings and pads included



Varifoot®
Compensates for uneven ground



Ergonomic quick release clamp



Reinforced tubes for superior strength and longevity



Keyboard stand

X-Form single

Product number	GKSX1
Type	Keyboard stands
Tube material	Steel
Tubing colour	Black
Tubing surface	Powder coated
Decks	1
Max. support depth	400 mm
Min. height	100 mm
Max. height	900 mm
Max. load (support)	55 kg
Interchangeable rings	1 x 15 mm, 4 x 20 mm, 4 x 30 mm
Black ring pack included	Yes
Number of Vari-Foot® incl.	1
Weight	2.98 kg



Keyboard stand

X-Form double

Product number	GKSX2B / W
Type	Keyboard stands
Tube material	Steel
Tubing colour	Black / white
Tubing surface	Powder coated
Decks	1
Max. support depth	400 mm
Min. height	100 mm
Max. height	900 mm
Max. load (support)	65 kg
Interchangeable rings	1 x 15 mm, 4 x 20 mm, 4 x 30 mm
Black ring pack included	Yes
Number of Vari-Foot® incl.	1
Weight	4.45 kg





MUSIC STANDS

Featuring friction-based height and tilt adjustment, the Gravity heavy duty orchestra-style music stand has been designed for easy handling and stability.

MUSIC STANDS

FEATURES



Aluminum plate



Foolproof operation,
knob free tilt and height
adjustment



Stable steel base

ORCHESTRA MUSIC STANDS

The NS ORC 1 is a rugged orchestra-style music stand designed for ultimate handling convenience. Height and support tilt adjustment rely on frictional force and do not require any set screws. All frictive parts are engineered for zero wear. The stand of powder coated steel features a lightweight 50 x 33.5 cm aluminum support.

Music Stand

Orchestra

Product number	GNSORC1
Type	Music stands
Music desk type	Panel
Stand material	Aluminium
Stand surface	Chromium plated, powder coated
Stand colour	Chromium
Support material	Aluminium
Support surface	Powder coated
Support colour	Black
Support width	500 mm
Support height	335 mm
Min. height	640 mm
Max. height	1200 mm
Transport length	1180 mm
Interchangeable rings	1 x 20 mm
Black rings pack included	Yes
Weight	2.7 kg

Tall Music Stand

Orchestra

Product number	GNSORC1L
Type	Music stands
Music desk type	Panel
Stand material	Steel
Stand surface	Chromium plated, powder coated
Stand colour	Black
Support material	Aluminium
Support surface	Powder coated
Support colour	Black
Support width	500 mm
Support height	335 mm
Min. height	655 mm
Max. height	1500 mm
Transport length	1195 mm
Interchangeable rings	1 x 20 mm
Black rings pack included	Yes
Weight	2.86 kg



MUSIC STANDS

PERFORATED DESK ORCHESTRA MUSIC STANDS

The NS ORC 2 orchestra music stand features a perforated sheet music desk of steel and heavy tripod base. It provides convenient no-knob friction height and desk tilt adjustment for use when seated or standing.

Music Stand

Orchestra

Product number	GNSORC2
Type	Music stands
Music desk type	Perforated music desk
Stand material	Aluminium
Stand surface	Chromium plated, powder coated
Stand colour	Chromium plated
Support model	Panel
Support material	Steel
Support surface	Powder coated
Support colour	Black
Support width	500 mm
Support height	335 mm
Min. height	640 mm
Max. height	1200 mm
Transport length	1180 mm
Interchangeable rings	1 x 20 mm
Black rings pack included	Yes
Weight	3.5 kg

Tall Music Stand

Orchestra

Product number	GNSORC2L
Type	Music stands
Music desk type	Perforated music desk
Stand material	Steel
Stand surface	Chromium plated, powder coated
Stand colour	Black
Support model	Panel
Support material	Steel
Support surface	Powder coated
Support colour	Black
Support width	500 mm
Support height	335 mm
Min. height	655 mm
Max. height	1500 mm
Transport length	1195 mm
Interchangeable rings	1 x 20 mm
Black rings pack included	Yes
Weight	3.66 kg







LIGHTING STANDS

Shine a light with Gravity®. Featuring premium materials and ultra durable construction, our lighting stands ensure years of reliable service, and our Vari-Pole® lets you position your fixtures virtually anywhere in any room.

LIGHTING STANDS



LARGE HEAVY STEEL BASE LIGHTING STAND

The LS 331 B lighting stand features a large heavy steel base providing a firm footing and a single extension for a maximum height of 2.4 m. The 35 mm pole includes a female threaded M10 insert, the base tube has a male M20 end. Two integrated base handles facilitate transport.

Square Steel Base for Lighting Stand

Product number	GLS331B
Type	Lighting stands
Tube material	Steel
Tubing colour	Black
Tubing surface	Powder coated
Min height:	1420 mm
Max height:	2420 mm
Transport length	1420 mm
Height adjustment	Set screw and safety pin
Number of extensions	1
Base material	Steel
Material of height adjustment	Steel
Tube diameter	35 mm, M10 threaded mm
Dimensions Base (W x H x D)	563 x 563 x 15 mm
Base weight	14 kg
Interchangeable rings	1 x 25 mm
Black ring pack included	Yes
Max. power handling	20 kg
Weight	17.8 kg

Optional Transport Bag available (GBGWBL331)





CLAMPING POLE VARI-POLE®

Made of lightweight, black anodized aluminium tubing with a secure locking mechanism, the Gravity VARI-POLE® extends from 210 cm to 370 cm and quickly mounts between floors and ceilings. It is held in place by pressure, and strong rubber on both sides for a variety of other applications.

Telescoping Pole with 210 - 370 cm length

Product number	GLSVARIPOLE01B
Type	Clamping rod
Material	Aluminium
Colour	Black
Tubing surface	Anodized
Connection Surface	Powder coated
Transport length	2100 mm
Clamping Range	2100 - 3700 mm
Upper Tube Diameter	40 mm
Lower Tube Diameter	45 mm
Weight	2.2 kg



LIGHTING STANDS

TWIN EXTENSION LIGHTING STAND

The SP 5522 B is a classic tripod speaker and lighting stand made from thick walled, yet lightweight powder coated steel tubing with a load capacity of 30 kg and twin extensions for a maximum height of 3 m. The diecast aluminium leg collar has been completely redesigned to provide superior durability and longevity. The unbreakable height adjustment collars are made of steel for additional strength featuring safety pins to securely lock the extensions in place. The ergonomic set screw knobs are made from high grade ABS with a soft touch, non-slip thermoplastic coating for comfortable handling. A set of black coding rings is included with the SP 5522 B, additional ring packs are available in a wide array of colours for instant personalization.



Speaker and Lighting Stand

Tall Version

Product number	GSP5522B
Type	Lighting stands
Tube material	Steel
Tube colour	Black
Tube surface	Powder coated
Max height:	3000 mm
Height-adjustable	Yes
Material of height adjustment	Steel
Number of extensions	2
Base type	Tripod
Base material	Die-cast aluminium
Tube diameter	35 mm
Max. load	30 kg
Interchangeable rings	5 x 30 mm
Black ring pack included	Yes
Weight	6.3 kg



FOLDABLE FLOOR STAND

The LS FLOORX B is a compact stand for placing light fixtures on the stage floor. The folding design of powder coated steel with ergonomic locking screw enables space saving storage, hefty rubber feet prevent marring of the floor while providing a secure grip.



Foldable Floor Stand for Spots

Product number	GLSFLOORXB
Type	Lighting stands
Material	Steel
Colour	Black
Surface	Powder-coated
Footprint	385 x 355 mm
Height	400 mm
Interchangeable rings	1 x 25 mm
Black ring pack included	Yes
Weight	0.4 kg



GUITAR STANDS

With guitar racks for multiple instruments, folding stands and wall mount hangers Gravity® has got guitar and bass players covered. Smart details such as our ingenious "Neck Hug" yoke mechanism and specially formulated rubber padding ensure your instrument stays where you put it. Gravity® guitar stands are suitable for acoustic, electric and bass guitars.



GUITAR STANDS



Folds up flat for transport and storage



Adjustable yokes with rubber padding



Straightforward, rock solid construction



Foam padding

VARI-G GUITAR RACKS

Designed for all acoustic, electric and bass guitars, Gravity guitar racks are available in three versions accommodating 3, 5 or 7 instruments. They are made of heavy-duty steel tubing with a black powder coating finish. Holding the necks firmly and securely the adjustable soft touch yokes are padded and detachable. The rails supporting the guitar bodies are covered in specifically formulated foam to prevent dents and scratches. Quick to set up and space saving, the Gravity guitar racks fold up flat for easy transport and storage.

Guitar Racks

for 3 to 7 Guitars

Product number	GGSMG03	GGSMG05	GGSMG07
Type	Guitar stands	Guitar stands	Guitar stands
Material	ABS plastic, TPU, EVA, steel	ABS plastic, TPU, EVA, steel	ABS plastic, TPU, EVA, steel
Surface	Powder-coated, soft-touch	Powder-coated / soft-touch	Powder-coated / soft-touch
Colour	Black	Black	Black
Suitable for	Electric guitars, acoustic guitars, bass guitars	Electric guitars, acoustic guitars, bass guitars	Electric guitars, acoustic guitars, bass guitars
Number of guitars	3	5	7
Height	780 mm	780 mm	780 mm
Depth	430 mm	430 mm	430 mm
Dimensions when folded (W x H x D)	400 x 780 x 80 mm	600 x 780 x 80 mm	800 x 780 x 80 mm
Interchangeable rings	4 x 25 mm, 2 x 20 mm	4 x 25 mm, 2 x 20 mm	4 x 25 mm, 2 x 20 mm
Black ring pack included	Yes	Yes	Yes
Weight	2.85 kg	3.2 kg	3.9 kg

GUITAR STANDS



Folds up flat for transport and storage



Soft rubber backrest and EVA padding



Straightforward, rock solid construction



Two angles of splay

SOLO-G A-FRAME GUITAR STANDS

The solo-G series consists of 3 stands for acoustic and classical guitars, for electric and bass guitars and a universal design that accommodates most body shapes. The A-frame stands are made of heavy-duty steel tubing with black powder coating finish, soft rubber backrest and EVA support arm padding to protect the instrument's finish and nonslip rubber feet. Providing two splay angle options, the tilt back Solo-G design folds up to compact dimensions nicely for easy portability.

A-Frame Guitar Stands

for Acoustic, Electric, and Bass Guitars

Product number	GGSA01A	GGSA01E	GGSA01U
Type	Guitar stands	Guitar stands	Guitar stands
Material	Steel	Steel	Steel
Surface	Powder-coated	Powder-coated	Powder-coated
Colour	Black	Black	Black
Suitable for	Acoustic guitars	Electric guitars and bass guitars	Acoustic guitars, electric guitars and bass guitars
Interchangeable rings	4 x 25 mm	4 x 25 mm	4 x 25 mm
Weight	1.21 kg	1.3 kg	1.3 kg

GUITAR STANDS

FOLDABLE GUITAR STAND

The GS 01 NHB is a rugged yet elegant folding guitar stand for acoustic, electric and bass guitars. It is easily height adjustable up to 108 cm and features Gravity's ingenious "Neck-Hug" technology.

The swivel mechanism automatically locks the guitar neck in the yoke to prevent slipping or falling out. The locking wings open again when the instrument is lifted from the stand. The stand's protective padding prevents dents and dings and does not mar the guitar's finish.

Foldable Guitar Stand Neckhug

Product number	GGS01NHB
Type	Guitar stands
Material	Steel
Colour	Black
Surface	Powder-coated
Suitable for	Electric guitars, acoustic guitars, bass guitars
Number of guitars	1
Width	500 mm
Min. height	680 mm
Max. height	1080 mm
Depth	400 mm
Interchangeable rings	4 x 25 mm
Black ring pack included	Yes
Weight	1.67 kg
Black ring set included	Yes



Automatically secures the guitar



Innovative neckhug technology



Quick release clamp for easy setup and adjustment



Foam padding

NECK-HUG GUITAR STAND

This universal wall mount hanger for acoustic, electric and bass guitars features Gravity's smart "Neck-Hug" technology. It automatically secures the neck in the yoke to prevent falling out. The locking wings open again when the instrument is lifted from the hanger. The yoke is coated with specially formulated rubber that does not mar the finish.



Wall Mount Guitar Hanger

Product number	GG501WMB
Type	Guitar stands
Material	Die-cast aluminium
Colour	Black
Surface	Powder coated
Suitable for	Acoustic guitars, bass, electric guitars
Number of guitars	1
Width	90 mm
Min. height	70 mm
Depth	140 mm
Interchangeable rings	1 x 25 mm
Black ring pack included	Yes
Weight	0.25 kg

GUITAR STANDS

WALL MOUNT GUITAR HANGER

The GS 08 WMB is a universal wall mount hanger for acoustic, electric and bass guitars. The yoke is self-adjusting to accommodate any headstock. It is coated with specially formulated rubber that provides a secure grip and does not mar the finish of your guitar.

Wall Mount Guitar Hanger

Product number	GGS08WMB
Type	Guitar Wall Mount Hanger
Material	Steel / plastic
Colour	Black
Surface	Rubber-coated
Suitable for	Electric guitars, acoustic guitars, bass guitars
Number of guitars	1
Interchangeable rings	1 x 25 mm
Weight	0.168 kg



Self-adjusting yoke



Non-marring rubber coating

AVAILABLE
SUMMER 2017

go play outside

PLUG-N-PLAY LI-ION BATTERY
FOR 6 HOURS CONTINUOUS PERFORMANCE



MAUI® 5 GO

THE WORLD'S FIRST
BATTERY POWERED
COLUMN PA SYSTEM

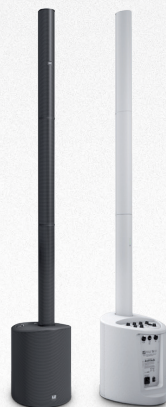

- UNLIMITED BATTERY POWER
THANKS TO QUICK-SWAPPING TECH (PATENT PENDING)
- LOUDEST BATTERY-POWERED SPEAKER
ON THE MARKET FOR CROWDS OF 100+ PEOPLE
- ULTRA-PORTABLE 4-PIECE DESIGN
WITH LESS THAN 13 KG
- BUILT-IN
4-CHANNEL MIXER
- BLUE TOOTH
STEREO AUDIO STREAMING
- ALL IN
ONE
- EXTENDED COVERAGE
THANKS TO LINE-ARRAY DESIGN

Combining **outstanding sound quality** and stunning **compact design** with the amazing versatility of **battery-operated** speakers, we've created an **ultra-portable PA system** for you: meet the **MAUI® 5 GO**. Powered by a **high-capacity Li-Ion battery**, the MAUI® 5 GO allows you to **play your music wherever you feel like**. And thanks to the optional, **quick-swappable battery packs**, you can also play for as long as you like. Now nothing can hold you back – **so GO play outside!**

LD SYSTEMS PRO AUDIO
IN MOTION

DESIGNED & ENGINEERED IN GERMANY
LD-SYSTEMS.COM



LD Systems® is a brand of **adam hall** experience event technology

SOUND
TECHNOLOGY

LIGHT
TECHNOLOGY

STAGE
EQUIPMENT

HARDWARE
FOR FLIGHTCASES

share the experience at
adamhall.com





ACCESSORIES

Gravity accessories include convenient carry bags, goose necks, speaker wall mount brackets and a wide range of other items. Browse our catalogue for the smart mic clip and boom coupler, quick swivel boom adapter, the highly adjustable monitor screen mount arm and much more. Gravity accessories have been designed to provide versatility, reliability and long lasting heavy duty use.

ACCESSORIES

DESK LAMP

The LED PL PRO is an elegant, discreet desk lamp with a gooseneck design for easy adjustment of your light positioning. It features 18 white LEDs with a colour rendering index greater than 70, and a touch sensor switch that includes a dimming function. The lamp is ideal for a wide variety of applications, and an integrated port allows for USB device charging to provide additional convenience.

LED Desktop & Piano Lamp with USB Port

Product number	GLEDPLPROB / W
Number of LEDs	18
Colour of LEDs	White
Gooseneck length	280 mm
Total length	730 mm
USB Port	Type A, DC 5 V, 1.5 A
Switches	Yes
Switch levels	High, low, medium, off, on
Colour temperature	6000 K +/- 500 K
Colour rendering index (CRI)	Over 75
Current draw	8 W (max. 19 W with USB) A
Power supply	AC 100 - 240 V to DC 12 V 2 A (included)
Weight	0.695 kg



Gooseneck section for easy and flexible adjustment



USB power out for charging 5 V DC, 1.5 A



Touch power/dim switch. Touch the surface to power on/off. Press and hold to dim



Power supply included



T-SHAPE DESK LAMP

The Gravity T-style piano lamp features 18 white LEDs for uniform illumination. The gooseneck end is easily flexible yet stays put where you bend it, and brightness is adjustable in 5 levels. It also provides a convenience USB port for charging smartphones and tablets and comes with a 12 V power adapter.



T-Shape Desktop & Piano Lamp with USB Port

Product number	GLEDPLTPROB
Number of LEDs	18
Colour of LEDs	White
Gooseneck length	280 mm
Total length	730 mm
USB Port	DC 5 V, 1.5 A
Switches	Yes
Switch levels	High, low, medium, off, on
Colour temperature	6000 K +/- 500 K
Colour rendering index (CRI)	Over 75
Illuminance	1100/800/500/300/100 lx +/-100
Current draw	8 W (max. 19 W with USB) A
Power supply	AC 100 - 240 V to DC 12 V 2 A (included)
Weight	0.69 kg

ACCESSORIES

MONITOR MOUNT

The SA 6131 B is an elegant steel and die-cast aluminum construction monitor screen mount arm. It is adjustable in all directions and features an ingenious counterbalance design for easy screen height adjustment.

The integrated cable management system ensures a clean and uncluttered installation. The producer screen arm ships with desk clamp and grommet for a wide variety of secure mounting options.



Monitor Mount

Tabletop-Mount, Swivel Arm

Product number	GSA6131B / GSA6132B
Type	Other stands and tripods
Material	Aluminum / steel
Colour	Black
Mounting option	Barrier strip / table mount
Suitable for Screens Size	13" - 27"
Number of Screens	1 / 2
Screen weight min.	2 kg
Screen weight max.	9 kg
Suitable for curved screens	Yes
Vesa standard	75 x 75 mm, 100 x 100 mm
Tilt movement	-90° - +90°
Swivel	180°
Rotate	360°
Max. length of arm	527 mm
Height	1400 mm
Height adjustment	Continuous
Cable management	Yes
Weight	3.85 kg / 6 kg



Gas spring and adjustable spring tension gauge



Swivel 180°, tilt -90° / +90°, rotation 360°, adjustable height



Integrated cable management



Table clamp included



Quick Coupler

for Mic Clips and Boom Arms

Product number	GMSQC1B
Type	Microphone stands
Material	Aluminum
Colour	Black
Surface	Powder coated
Height	90 mm
Thread stand	5/8"
Thread microphone	3/8"
Weight	0.13 kg



GMSQC1B
Quick Coupler
Crown
individually
available



Microphone Holder

Product number	GMAMH01
Type	Microphone holder
Colour	Black
Material	Steel
Surface	Powder coated
Suitable for tube diameter	Up to 30 mm
Threaded connector	3/8"
Length	160 mm
Interchangeable rings	2 x 20 mm
Black ring pack included	Yes
Weight	0.14 kg



ACCESSORIES



Table Clamp for Microphones

Product number	GMSTM1B
Type	Microphone holder
Colour	Black
Material	Aluminum
Surface	Powder coated
Thread connector	3/8"
For table top thickness	Up to 45 mm
Interchangeable rings	1 x 20 mm
Weight	0.185 kg



Mic Adapter quick tilt Ball Joint

Product number	GMSQT1B
Colour	Black
Material	Aluminum
Surface	Powder coated
Thread connector	3/8"
Length	55 mm
Interchangeable rings	1 x 20 mm
Black rings pack included	Yes
Weight	0.086 kg





Microphone Dock

for mounting on Guitar Amplifiers and Cabinets

Product number	GMSAMPDS01
Type	Microphone holder
Material	Zink die-cast
Surface	Powder coated
Colour	Black
Thread connector	3/8", 5/8"
Width	42 mm
Depth	48 mm
Weight	0.12 kg
Additional information	Rubber for decoupling included , screw set



Microphone Clamp

for 24 - 35 mm Diameters

Product number	GMSCLMP25
Type	Microphone clip
Material	Plastic
Microphone mount (diameter)	24 - 35 mm
Base Thread	5/8"
Features	3/8"
Interchangeable rings	1 x 20 mm
Black ring pack included	Yes
Weight	0.05 kg



ACCESSORIES



Microphone Stand Tray

Product number	GMATRAY1
Type	Stands and tripod accessories
Material	Steel
Colour	Black
Suitable for mounting on	Microphone stand
Support width	250 mm
Support depth	195 mm
Extension Length	200 mm
Black ring pack included	Yes
Weight	1.1 kg

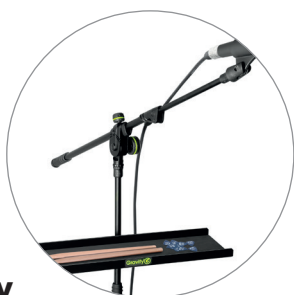

Microphone Stand Tray

Product number	GMATRAY2
Type	Stands and tripod accessories
Material	Steel
Colour	Black
Suitable for mounting on	Microphone stand
Support width	400 mm
Support depth	130 mm
Extension Length	50 mm
Black ring pack included	Yes
Weight	0.4 kg





Headphones Holder

for Microphone Stand / Table Mount / Wall Mount

Product number	GPHMS01B	GPHTC01B	GPHWMB01B
Type	Headphones	Headphones	Headphones
Material	Plastic / steel	Plastic / steel	Plastic / steel
Colour	Black	Black	Black
Mounting options	Microphone stand	Table	Wall
Support width	60 mm	60 mm	60 mm
Deck depth	100 mm	100 mm	100 mm
Interchangeable rings	1 x 20 mm	1 x 20 mm	No
Black ring set included	Yes	Yes	No
Weight	0.175 kg	0.25 kg	0.2 kg

ACCESSORIES

Quick Swivel Boom Adapter

Product number	GMSQS1B
Colour	Black
Material	Steel
Surface	Poeder coated
Threaded connector	3/8
Length	54 mm
Black ring path included	Yes
Weight	0.126 Kg



3/8" male and female threads



Quick horizontal boom positioning



Large ergonomic set-screw knob



Gooseneck
extra long 600 mm

Product number	GMAGOOSEXL
Type	Gooseneck
Material	Steel
Colour	Black
Connector 1	3/8" thread
Connector 2	3/8" thread
Length	600 mm
Diameter	15 mm
Weight	0.47 kg



Gooseneck
long 460 mm

Product number	GMAGOOSEL
Type	Gooseneck
Material	Steel
Colour	Black
Connector 1	3/8" thread
Connector 2	3/8" thread
Length	460 mm
Diameter	15 mm
Weight	0.41 kg



Gooseneck
medium 320 mm

Product number	GMAGOOSEM
Type	Gooseneck
Material	Steel
Colour	Black
Connector 1	3/8" thread
Connector 2	3/8" thread
Length	320 mm
Diameter	15 mm
Weight	0.26 kg



Gooseneck
short 140 mm

Product number	GMAGOOSES
Type	Gooseneck
Material	Steel
Colour	Black
Connector 1	3/8" thread
Connector 2	3/8" thread
Length	140 mm
Diameter	15 mm
Weight	0.12 kg





Transport Bag for 6 Microphone Stands

Product number	GBGMS6B
For number of stands	6
For type of stand	Microphone stand
Colour	Black
Material	Nylon 600D
Thickness of the padding	5 mm
Latch	Zip
Width	1050 mm
Height	330 mm
Depth	330 mm
Weight	1.8 kg



Transport Bag for 6 short Microphone Stands

Product number	GBGMS6SB
For number of stands	6
For type of stand	Microphone stand
Colour	Black
Material	Nylon 600D
Thickness of the padding	5 mm
Latch	Zip
Width	680 mm
Height	330 mm
Depth	330 mm
Weight	1.5 kg



ACCESSORIES



Transport Bag for 2 Speaker Stands

Product number	GBGSS2B
Type	Stands and tripod accessories
For number of stands	2
For type of stand	Speaker tripod
Colour	Black
Material	Nylon 600D
Thickness of the padding	15 mm
Latch	Double zip
Width	1070 mm
Height	190 mm
Depth	290 mm
Transport length	1050 mm
Weight	1 kg



Transport Bag for Square Base Plate

Product number	GBGWBL331
Type	Stands and tripod accessories
Colour	Black
Material	Nylon 1680D
Thickness of the padding	5 mm
Width	563 mm
Height	563 mm
Latch	Zip
Weight	0.65 kg

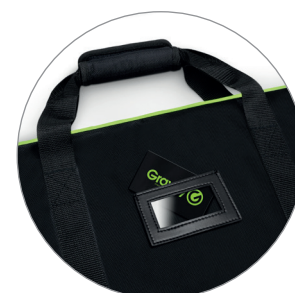



Transport Bag for 2 Speaker Stands long

Product number	GBGSS2LB
Type	Stands and tripod accessories
For number of stands	2
For type of stand	Speaker tripod
Colour	Black
Material	Nylon 600D
Thickness of the padding	15 mm
Latch	Double zip
Width	1200 mm
Height	190 mm
Depth	290 mm
Transport length	1200 mm
Weight	1 kg



Transport Bag for 450 mm Round Base Plate

Product number	GBGWB123
Type	Stands and tripod accessories
Colour	Black
Material	Nylon 1680D
Thickness of the padding	5 mm
Diameter	480 mm
Latch	Zip
Weight	0.37 kg



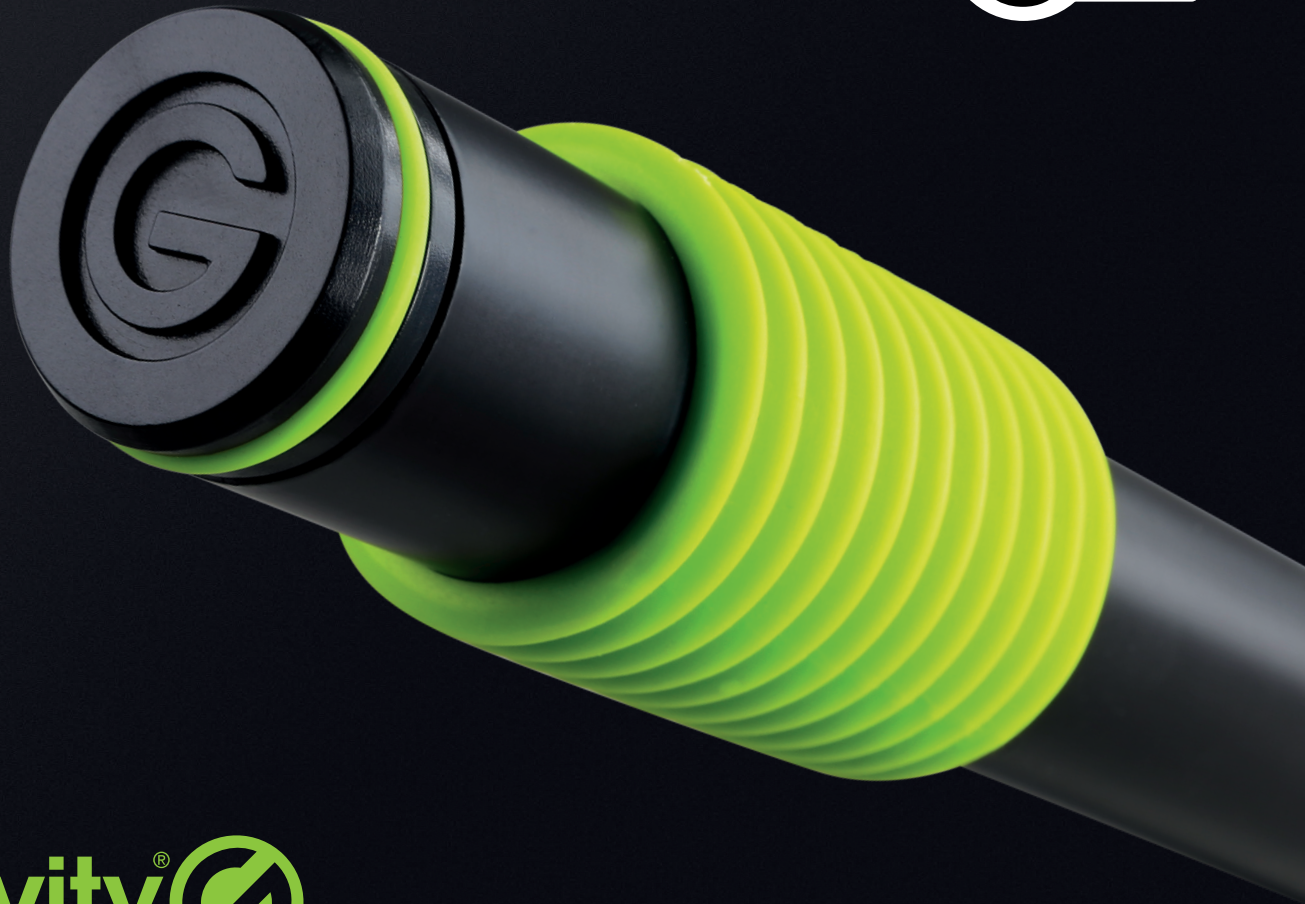

PREMIUM STANDS CATALOGUE

DESIGNED & ENGINEERED
IN GERMANY.

gravitystands.com



www.facebook.com/gravitystands
www.youtube.com/gravitystands
blog.adamhall.com

EDITION 2017/2



The information contained in this publication, including numerical data, has been prepared as a general guide to the products, but intending buyers and users must satisfy themselves as to the suitability and the safety of the products for their particular purposes and duties. No responsibility is assumed for any errors herein. The company reserves the right to alter the designs and material specifications of products shown in this publication without notice.